

## 8.5-10.5 GHz Low Noise Amplifier

### Features

- ◆ Frequency Range : 8.5-10.5 GHz
- ◆ Low Noise Figure < 1.5 dB
- ◆ 30 dB nominal gain
- ◆ 14 dBm P<sub>1dB</sub>
- ◆ High IP3
- ◆ Input Return Loss > 10 dB
- ◆ Output Return Loss > 10 dB
- ◆ Single supply operation
- ◆ No external matching required
- ◆ DC decoupled input and output
- ◆ 0.15 μm InGaAs pHEMT Technology
- ◆ Chip dimension: 3.3 x 2.9 x 0.1 mm

Functional Diagram

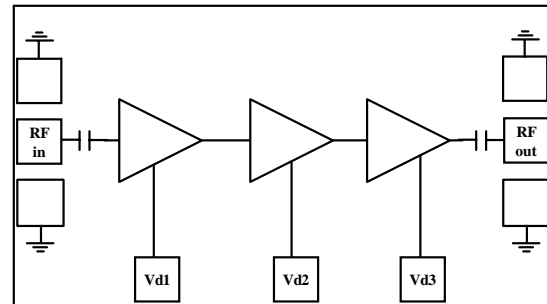

### Typical Applications

- ◆ RADAR
- ◆ Military
- ◆ Test Equipment and sensors
- ◆ Point-to-Point Radios, Point-to-Multi-Point Radios & VSATS

### Description

The AMT2142021 is a three stage ultra low noise amplifier that operates from 8.5-10.5 GHz. The LNA features 30 dB gain and has a typical mid-band noise figure of 1.3 dB. The LNA has nominal input/output return losses of 10 dB. The nominal P1dB is 14 dBm. The LNA operates on a single positive supply. The die is fabricated using a reliable 0.15μm InGaAs pHEMT technology. The Circuit grounds on the die are provided through vias to backside metallization.

The ASTRA 2142021 performs well as a low noise amplifier in receive applications and as a driver or buffer amplifier where high gain, excellent linearity and low power consumption are important.

### Absolute Maximum Ratings<sup>(1)</sup>

Parameter	Absolute Maximum	Units
Drain Voltage	+6	V
Input RF Power	+10	dBm
Operating Temperature	-55 to +85	°C
Storage Temperature	-65 to +150	°C

1. Operation beyond these limits may cause permanent damage to the component

**Electrical Specifications @  $T_A = 25^\circ\text{C}$ ,  $V_{d1} = 2\text{V}$ ,  $V_{d2} = V_{d3} = 4\text{V}$   $Z_o = 50\ \Omega$** 

Parameter	Typ	Units
Frequency Range	8.5 -10.5	GHz
Gain	30	dB
Gain Flatness	$\pm 1.2$	dB
Noise Figure	1.5	dB
Input Return Loss	10	dB
Output Return Loss	10	dB
Output Power (P1dB)	+14	dBm
Saturated Output Power (Psat)	+17	dBm
Output Third Order Intercept (IP3)	27	dBm
Supply Current (Id) ( $V_{d1} = 2\text{V}$ , $V_{d2} = V_{d3} = 4\text{V}$ )	75	mA

**Note:**

1. Electrical specifications as measured in a test fixture.

**Test fixture data**

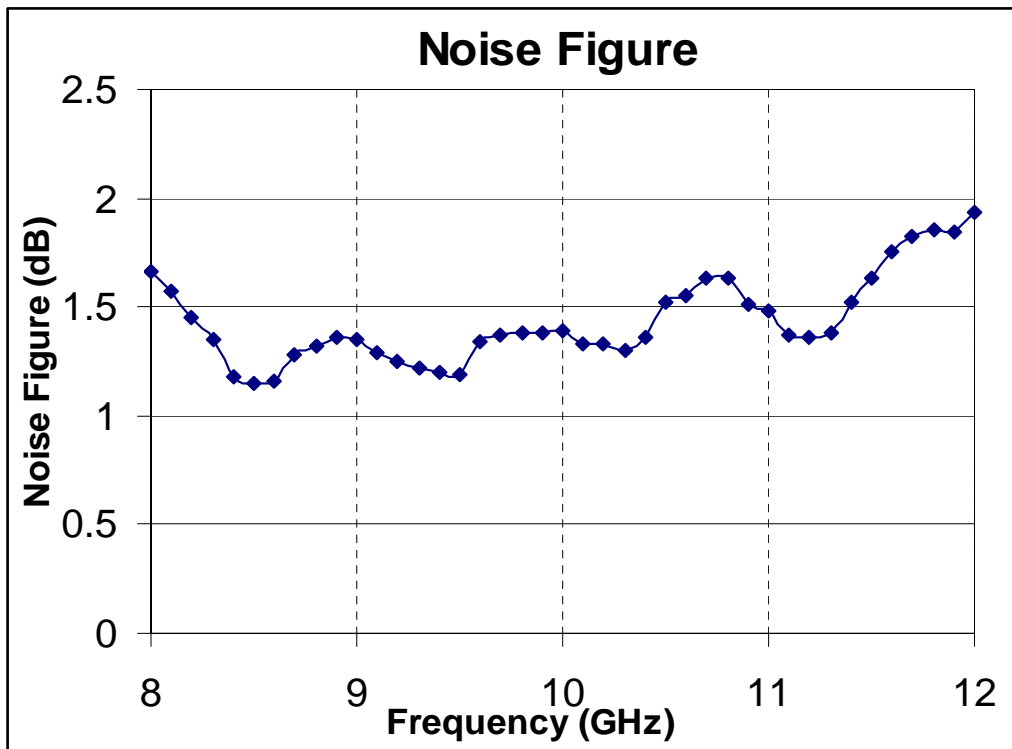
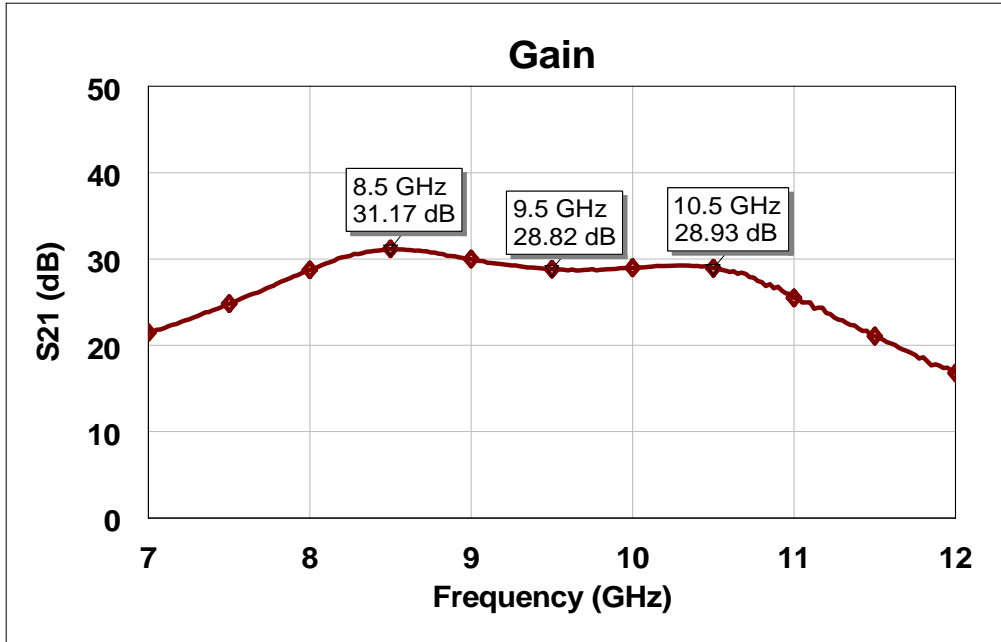
 Vd1=2V, Vd2=Vd3=4V, Total Current =75ma, T<sub>A</sub> = 25 °C

**Test fixture data**

$V_{d1}=2V$ ,  $V_{d2} = V_{d3} = 4V$ , Total Current =75ma,  $T_A = 25^\circ C$

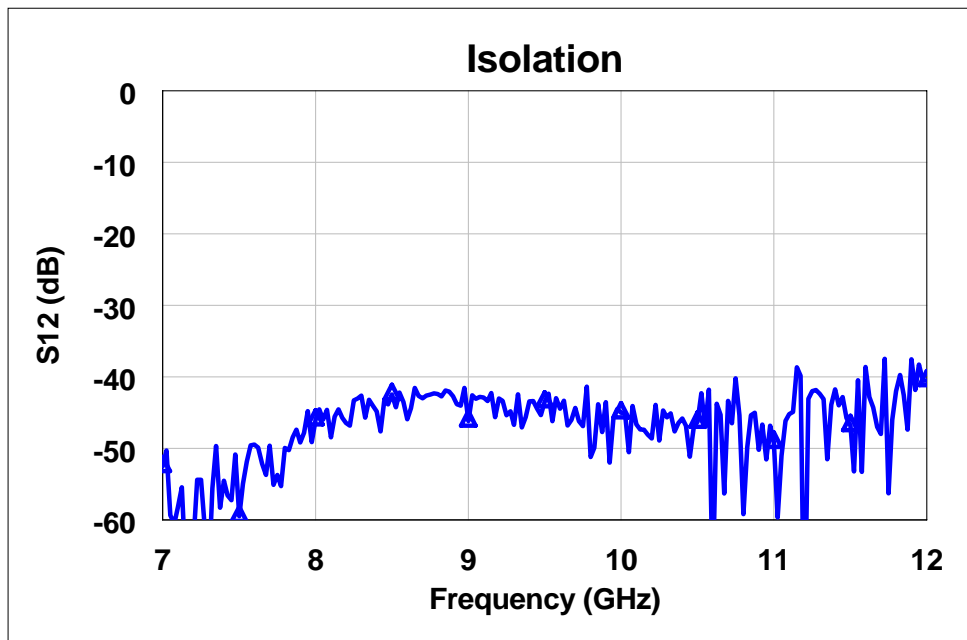
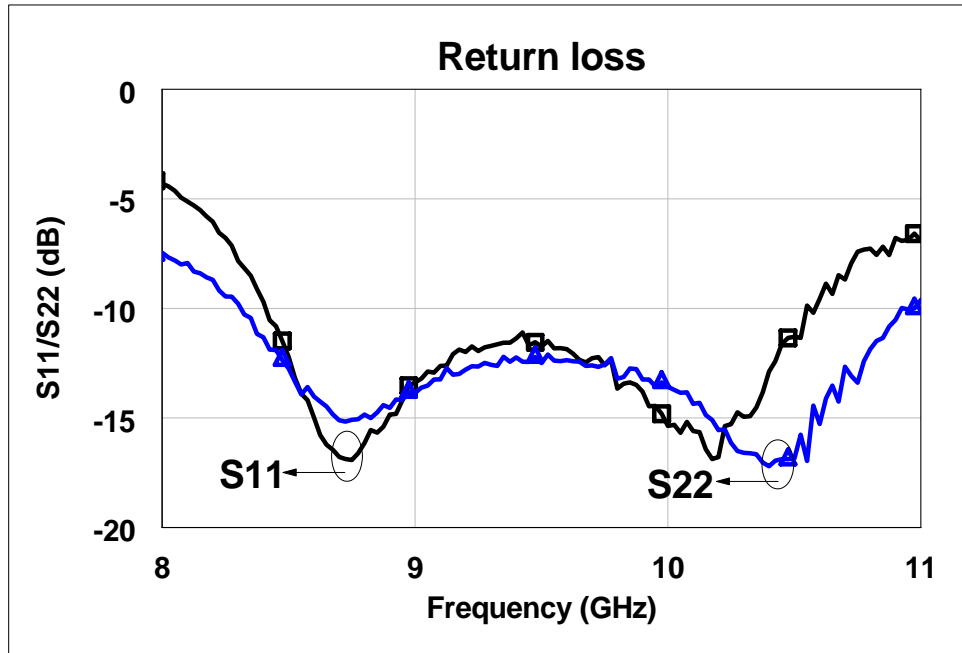

**Test fixture data**

$V_{d1}=2V$ ,  $V_{d2} = V_{d3} = 4V$ , Total Current =75ma,  $T_A = 25\text{ }^\circ\text{C}$

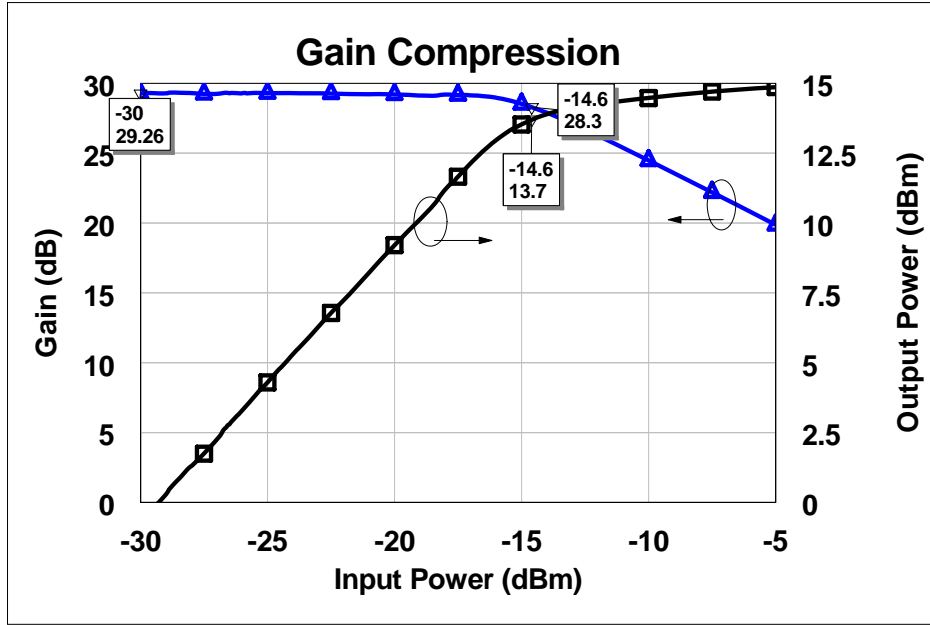

## Mechanical Characteristics

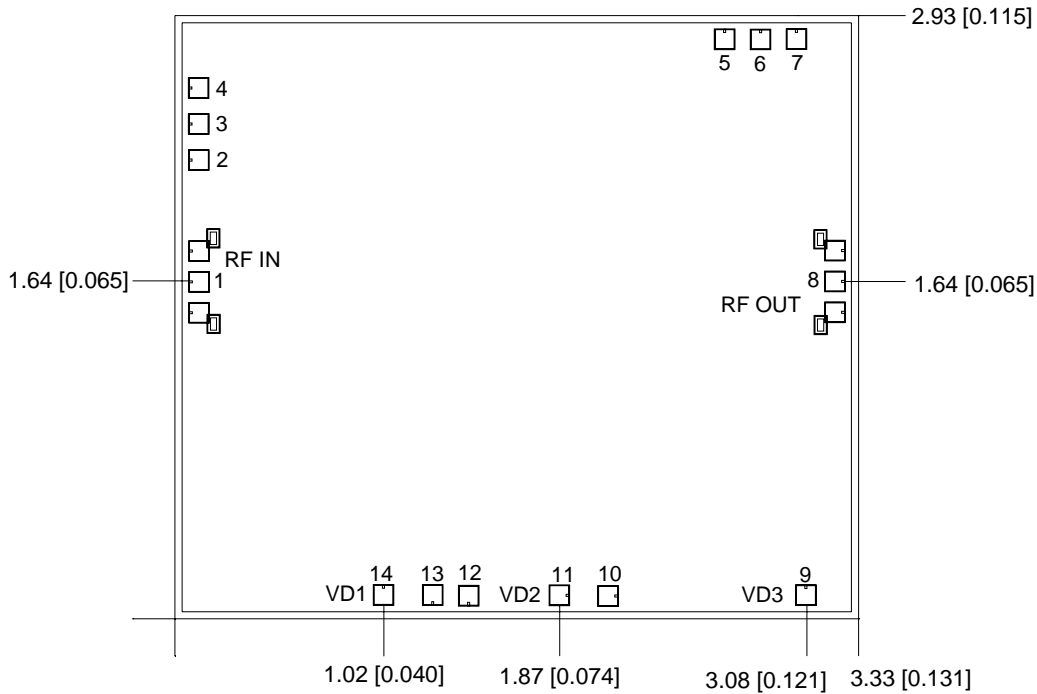

**Units: Millimeters [Inches]**

**All RF and DC bond pads are 100µm x 100µm**

**Note:**

1. Pad no. 14: Vd1
2. Pad no. 11: Vd2
3. Pad no. 9 : Vd3
5. Pad no. 1 : RF Input
6. Pad no. 8 : RF Output

## Recommended Assembly Diagram

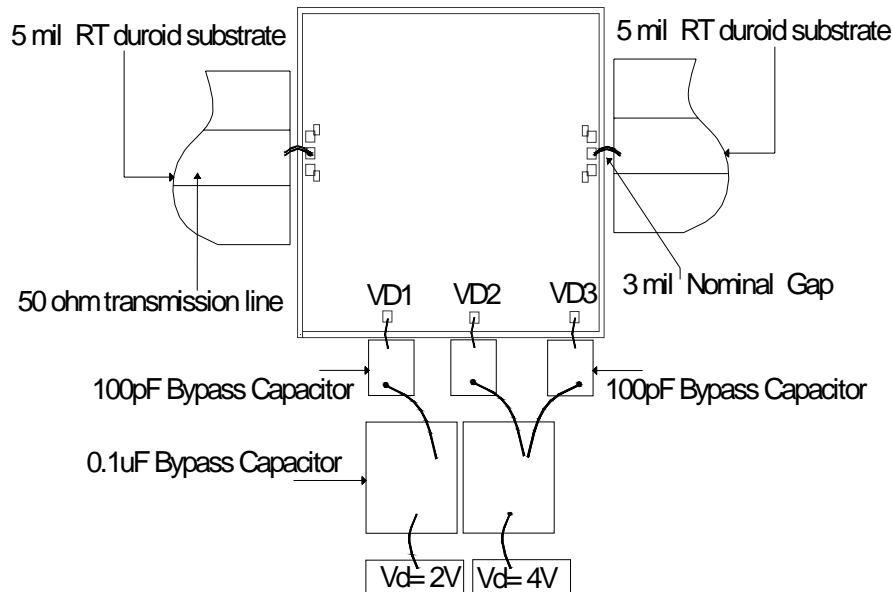

### Note:

1. Two 1 mil (0.0254mm) bond wires of minimum length should be used for RF input and output.
2. Two 1 mil (0.0254mm) bond wires of minimum length should be used from chip bond pad to 100pF capacitor.
3. Input and output 50 ohm lines are on 5 mil substrate.
4. 0.1  $\mu$ F capacitors may be additionally used as a second level of bypass for reliable operation.

**Die attach:** For Epoxy attachment, use of a two-component conductive epoxy is recommended. An epoxy fillet should be visible around the total die periphery. If Eutectic attachment is preferred, use of fluxless AuSn (80/20) 1-2 mil thick preform solder is recommended. Use of AuGe preform should be strictly avoided.

**Wire bonding:** For DC pad connections use either ball or wedge bonds. For best RF performance, use of 150 - 200 $\mu$ m length of wedge bonds is advised. Single Ball bonds of 250-300 $\mu$ m though acceptable, may cause a deviation in RF performance.



***GaAs MMIC devices are susceptible to Electrostatic discharge. Proper precautions should be observed during handling, assembly & testing***

All information and Specifications are subject to change without prior notice