

5.0 – 7.0 GHz 6-Bit Digital Phase Shifter

Features

- ◆ Frequency Range: 5 to 7 GHz
- ◆ RMS Error < 3 deg.
- ◆ Low Insertion Loss ~ 5dB
- ◆ TTL Control Inputs
- ◆ 0.5-um InGaAs pHEMT Technology
- ◆ Chip Size : 4.0mm x 2.2 mm x 0.1 mm

Functional Diagram

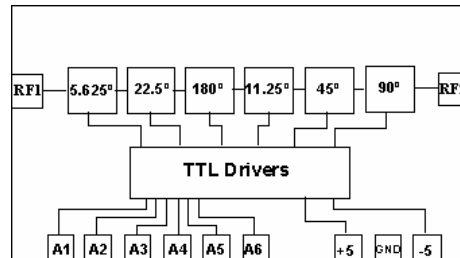

Typical Applications

- ◆ Radar
- ◆ Military & Space
- ◆ Instrumentation

Description

The AMT2231031 is a 6-bit digital phase shifter MMIC designed to operate over a frequency band of 5-7 GHz. The phase shifter features a low RMS phase error of less than 3.3 deg over the entire operating band. The insertion loss is 5.8 dB maximum and varies within ± 1 dB over the band and the 64 phase states. The input /output ports are well matched to 50 Ohms. The integrated TTL compatible drivers provide a convenient digital interface for 6-bit control. The chip operates on +5V /-5V DC supply voltages with a low current. The MMIC die is fabricated using a robust 0.5 μ m InGaAs pHEMT technology.

Absolute Maximum Ratings ⁽¹⁾

Parameter	Absolute Maximum	Units
RF Input Power	25	dBm
Positive Supply Voltage	+6	V
Negative Supply Voltage	-6	V
Control Voltage		
ON	+5 to +5.5	V
OFF	-0.5 to 0	V
Operating Temperature	-40 to +85	°C
Storage Temperature	-65 to +150	°C

1. Operation beyond these limits may cause permanent damage to the component

Electrical Specifications ⁽¹⁾ @ T_A = 25 °C, Z_o =50 Ω

Parameter	Value	Units
Frequency	5.0 – 7.0	GHz
Phase Shift	0-360 in 64 steps	deg
Insertion Loss (Typ.)	4.8	dB
Insertion Loss Variation	± 1.0	dB
Peak Phase Error	-11 to +7	deg
RMS Error	3.0	deg
Port1 Return Loss	9	dB
Port2 Return Loss	10	dB
Pin for 1dB compression	20	dBm
DC Supply	+5/6, -5/3	V/mA
Control Voltage	TTL compatible	
ON	+3 to +5 V	V
OFF	0 to +0.5 V	V

Note:

1. The above mentioned electrical specifications are measured On-Wafer.

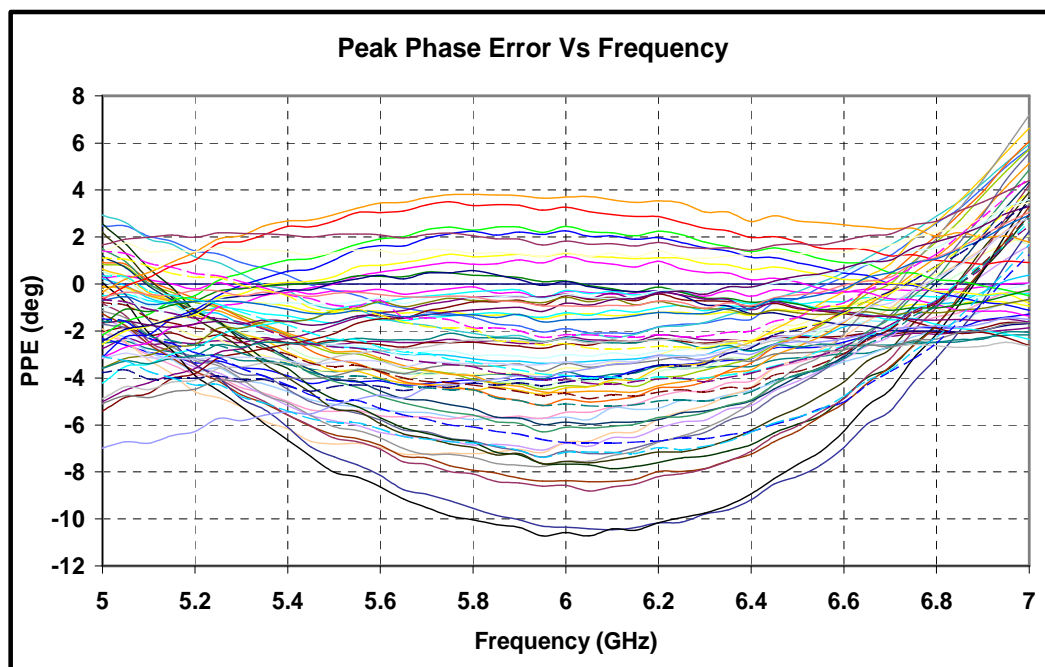
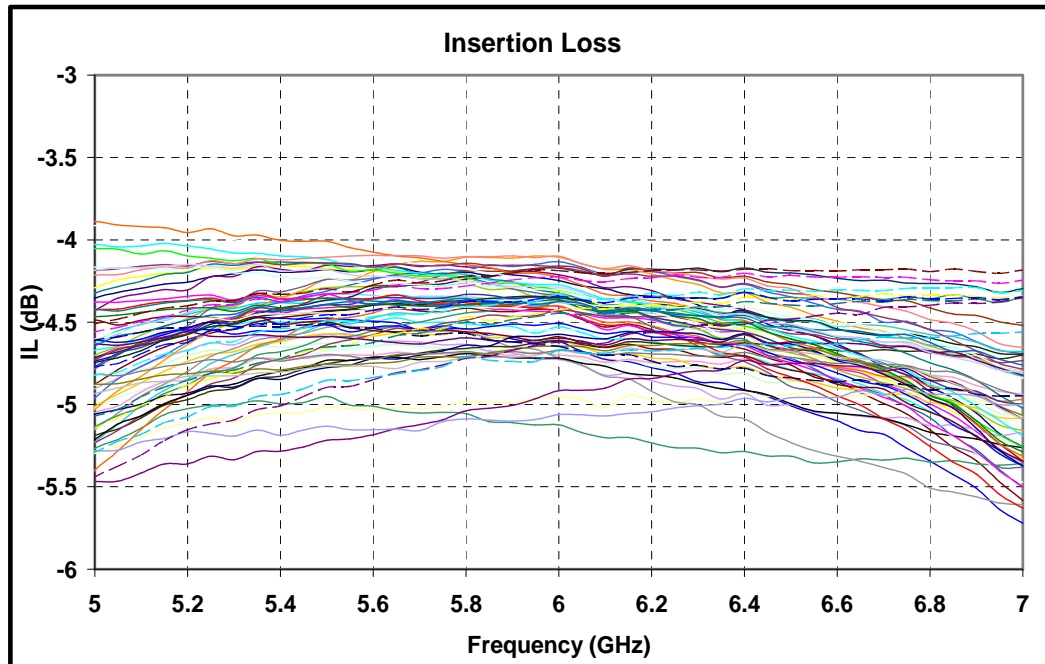
On Wafer data $T_A = 25^\circ\text{C}$ 

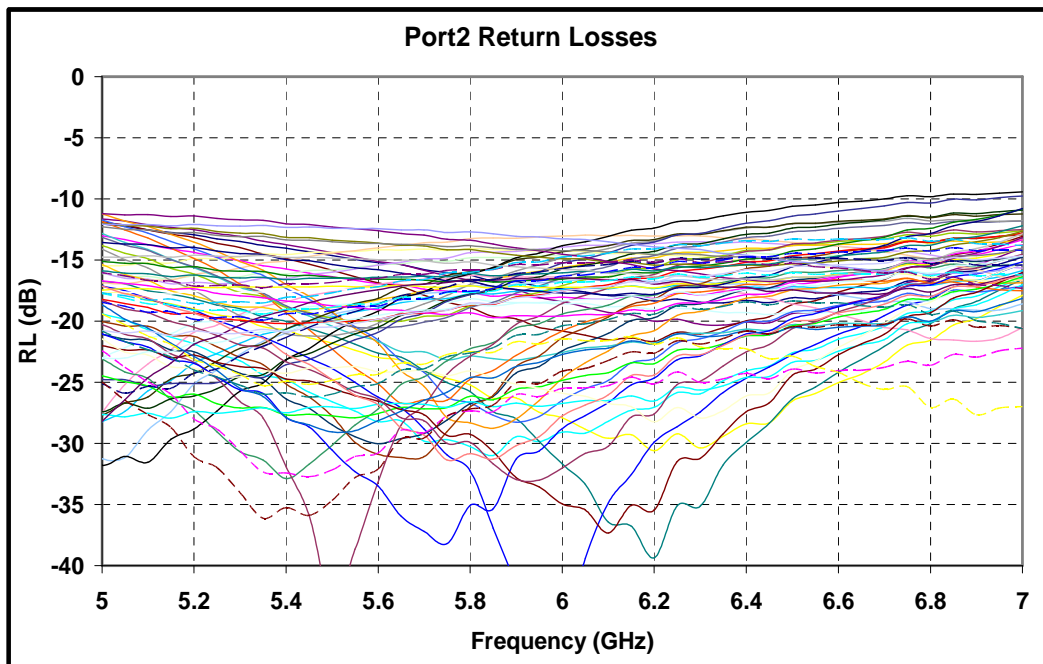
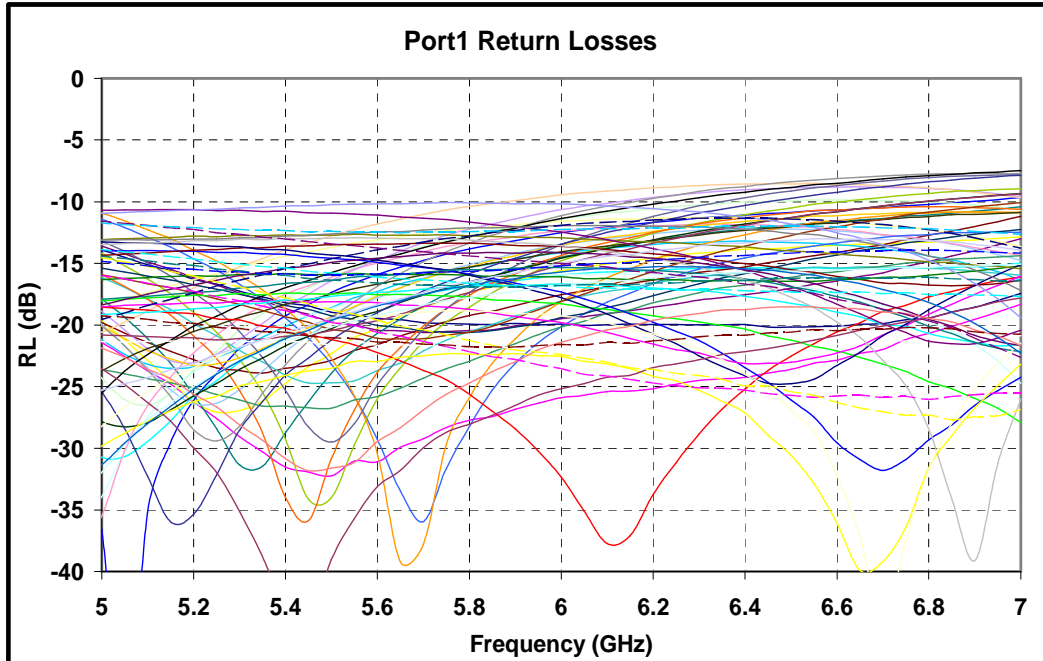
On Wafer data $T_A = 25^\circ\text{C}$ 

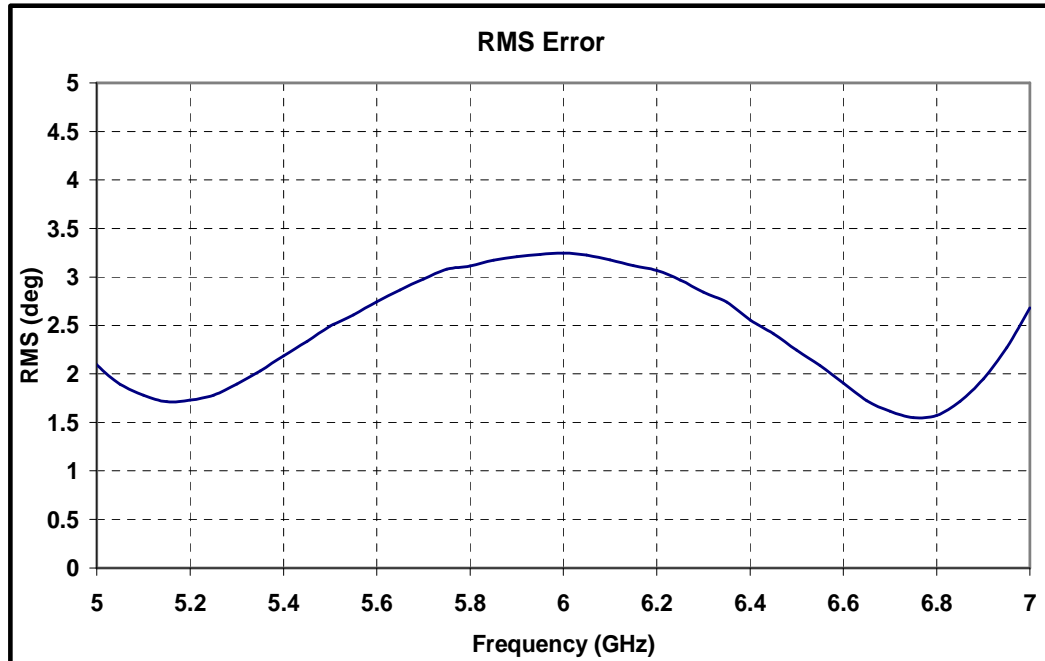
On Wafer data $T_A = 25^\circ\text{C}$ 

Truth Table

State	Phase Shift (deg.)	TTL Control (1 = 3.5 to 5 V, 0 = 0 to 0.5 V)					
		A6 (180)	A5 (90)	A4 (45)	A3 (22.5)	A2 (11.25)	A1 (5.625)
0	0	0	0	0	0	0	0
1	5.625	0	0	0	0	0	1
2	11.25	0	0	0	0	1	0
3	16.875	0	0	0	0	1	1
4	22.5	0	0	0	1	0	0
5	28.125	0	0	0	1	0	1
6	33.75	0	0	0	1	1	0
7	39.375	0	0	0	1	1	1
8	45	0	0	1	0	0	0
9	50.625	0	0	1	0	0	1
10	56.25	0	0	1	0	1	0
11	61.875	0	0	1	0	1	1
12	67.5	0	0	1	1	0	0
13	73.125	0	0	1	1	0	1
14	78.75	0	0	1	1	1	0
15	84.375	0	0	1	1	1	1
16	90	0	1	0	0	0	0
17	95.625	0	1	0	0	0	1
18	101.25	0	1	0	0	1	0
19	106.875	0	1	0	0	1	1
20	112.5	0	1	0	1	0	0
21	118.125	0	1	0	1	0	1
22	123.75	0	1	0	1	1	0
23	129.375	0	1	0	1	1	1
24	135	0	1	1	0	0	0
25	140.625	0	1	1	0	0	1
26	146.25	0	1	1	0	1	0
27	151.875	0	1	1	0	1	1
28	157.5	0	1	1	1	0	0
29	163.125	0	1	1	1	0	1
30	168.75	0	1	1	1	1	0
31	174.375	0	1	1	1	1	1
32	180	1	0	0	0	0	0
33	185.625	1	0	0	0	0	1
34	191.25	1	0	0	0	1	0
35	196.875	1	0	0	0	1	1

Truth Table

State	Phase Shift (deg.)	TTL Control (1 = 3.5 to 5 V, 0 = 0 to 0.5 V)					
		A6 (180)	A5 (90)	A4 (45)	A3 (22.5)	A2 (11.25)	A1 (5.625)
36	202.5	1	0	0	1	0	0
37	208.125	1	0	0	1	0	1
38	213.75	1	0	0	1	1	0
39	219.375	1	0	0	1	1	1
40	225	1	0	1	0	0	0
41	230.625	1	0	1	0	0	1
42	236.25	1	0	1	0	1	0
43	241.875	1	0	1	0	1	1
44	247.5	1	0	1	1	0	0
45	253.125	1	0	1	1	0	1
46	258.75	1	0	1	1	1	0
47	264.375	1	0	1	1	1	1
48	270	1	1	0	0	0	0
49	275.625	1	1	0	0	0	1
50	281.25	1	1	0	0	1	0
51	286.875	1	1	0	0	1	1
52	292.5	1	1	0	1	0	0
53	298.125	1	1	0	1	0	1
54	303.75	1	1	0	1	1	0
55	309.375	1	1	0	1	1	1
56	315	1	1	1	0	0	0
57	320.625	1	1	1	0	0	1
58	326.25	1	1	1	0	1	0
59	331.875	1	1	1	0	1	1
60	337.5	1	1	1	1	0	0
61	343.125	1	1	1	1	0	1
62	348.75	1	1	1	1	1	0
63	354.375	1	1	1	1	1	1

Mechanical Characteristics

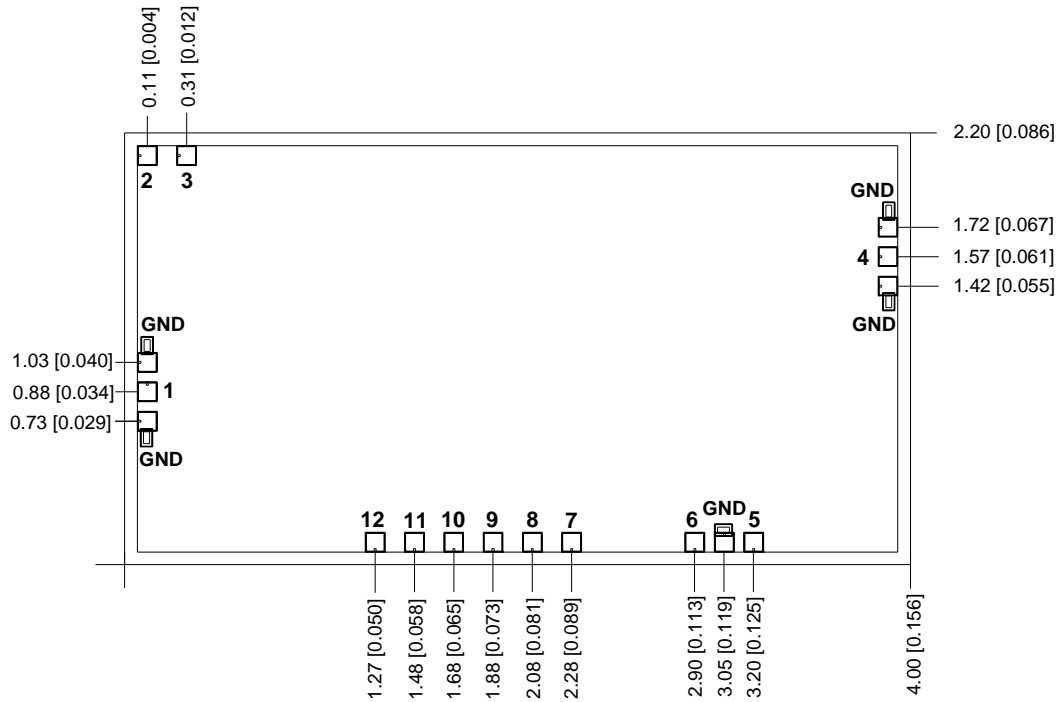

Units: millimeters (inches)

Note:

1. All RF and DC bond pads are 100µm x 100µm
2. Pad no. 1 : RF1
3. Pad no. 2 : Optional -5 V
4. Pad no. 3 : Optional +5 V
5. Pad no. 4 : RF2
6. Pad no. 5 : -5 V
7. Pad no. 6 : +5 V
8. Pad no. 7 to 12 : A6 to A1 (Control bits from MSB to LSB)

Recommended Assembly Diagram

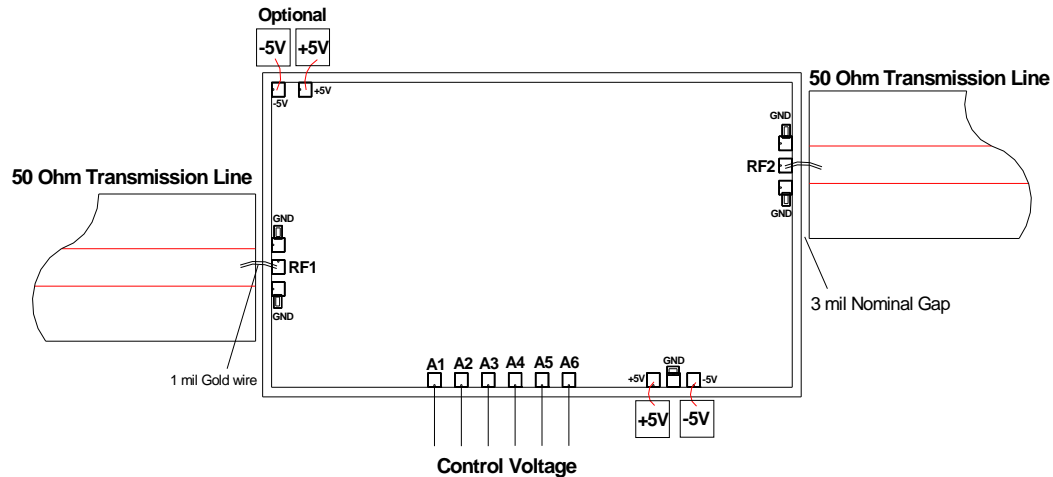
Note :

1. Two 1 mil (0.0254mm) bond wires of minimum length should be used for RF input and output.
2. The RF input & output ports are DC coupled.

Die attach: For Epoxy attachment, use of a two-component conductive epoxy is recommended. An epoxy fillet should be visible around the total die periphery. If Eutectic attachment is preferred, use of fluxless AuSn (80/20) 1-2 mil thick preform solder is recommended. Use of AuGe preform should be strictly avoided.

Wire bonding: For DC pad connections use either ball or wedge bonds. For best RF performance, use of 150 - 200 μ m length of wedge bonds is advised. Single Ball bonds of 250-300 μ m though acceptable, may cause a deviation in RF performance.



GaAs MMIC devices are susceptible to Electrostatic discharge. Proper precautions should be observed during handling, assembly & testing

All information and Specifications are subject to change without prior notice