

5.0 – 6.0 GHz 6-Bit Digital Phase Shifter

Features

- ◆ Frequency Range: 5.0 to 6.0 GHz
- ◆ RMS Error < 3 deg.
- ◆ 7 dB Insertion Loss
- ◆ TTL Control Inputs
- ◆ 0.5-um InGaAs pHEMT Technology
- ◆ 28 Lead 7.0 x 7.0 x 1.2 mm³ QFN Package

Typical Applications

- ◆ Radar
- ◆ Military & Space
- ◆ Instrumentation

Functional Diagram

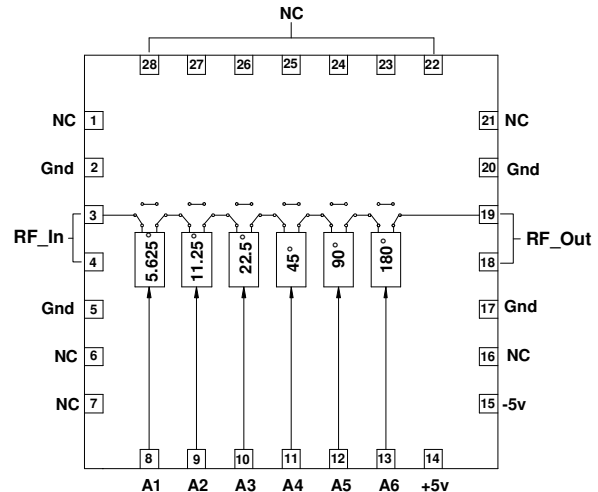

Description

The AMT2231022OP is a 6-bit digital phase shifter MMIC packaged in a QFN package. It is designed to operate over a frequency band of 5.0 – 6.0 GHz. The phase shifter features a low RMS error of 2 deg in the mid band. The midband insertion loss is 7.0 dB and varies within ± 0.8 dB over the band and the 64 phase states. The input/output ports are well matched to 50 Ohms. The integrated TTL compatible drivers provide a convenient digital interface for 6-bit control. The package operates with +5V and -5V DC supply at a very low current.

Absolute Maximum Ratings ⁽¹⁾

Parameter	Absolute Maximum	Units
RF Input Power	30	dBm
Positive Supply Voltage	+6	V
Negative Supply Voltage	-6	V
Control Voltage		
ON	+5 to +5.5	V
OFF	-0.5 to 0	V
Operating Temperature	-40 to +85	°C
Storage Temperature	-65 to +150	°C

1. Operation beyond these limits may cause permanent damage to the component

Electrical Specifications ⁽¹⁾ @ T_A = 25 °C, Z_o =50 Ω

Parameter	Value	Units
Frequency	5.0 – 6.0	GHz
Phase Shift	0-360 in 64 steps	deg
Insertion Loss (Typ.)	7.0	dB
Insertion Loss Variation	± 0.8	dB
Peak Phase Error	-6 to +6	deg
RMS Error (Mid band)	2.0	deg
Port1 Return Loss (Typ.)	10	dB
Port2 Return Loss (Typ.)	10	dB
Input Power for 1dB Compression ⁽²⁾	23	dBm
Input IP3 ^{(2), (3)}	32	dBm
DC Supply	+5/6, -5/3	V/mA
Control Voltage	TTL Compatible	
ON	+5	V
OFF	0	V
Switching Speed	40	ns

Note:

1. The above mentioned electrical specifications are measured on PCB mounted QFN package.
2. Measured for Major states only.
3. Two-Tone Input Power = 0dBm each tone, 10MHz Tone separation

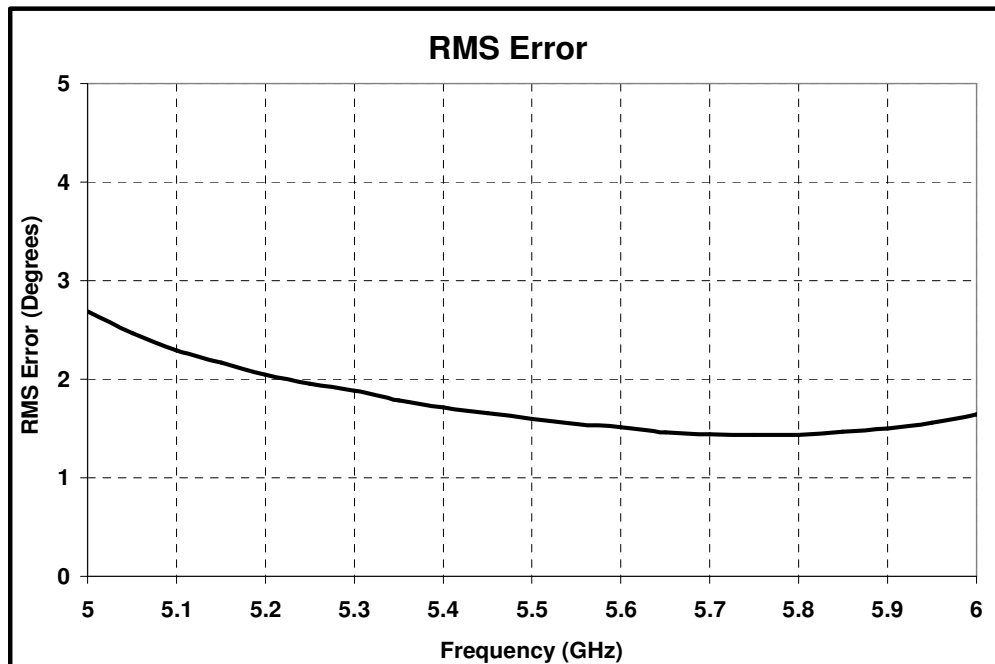
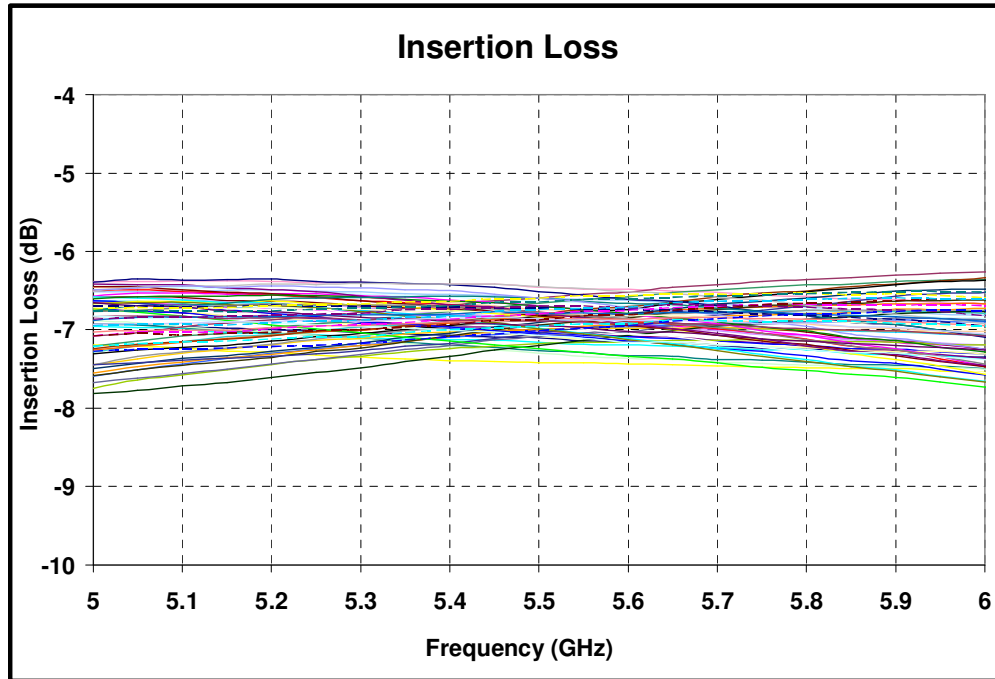
Test Fixture Data $T_A = 25^\circ\text{C}$ 

Test Fixture Data

$T_A = 25^\circ C$

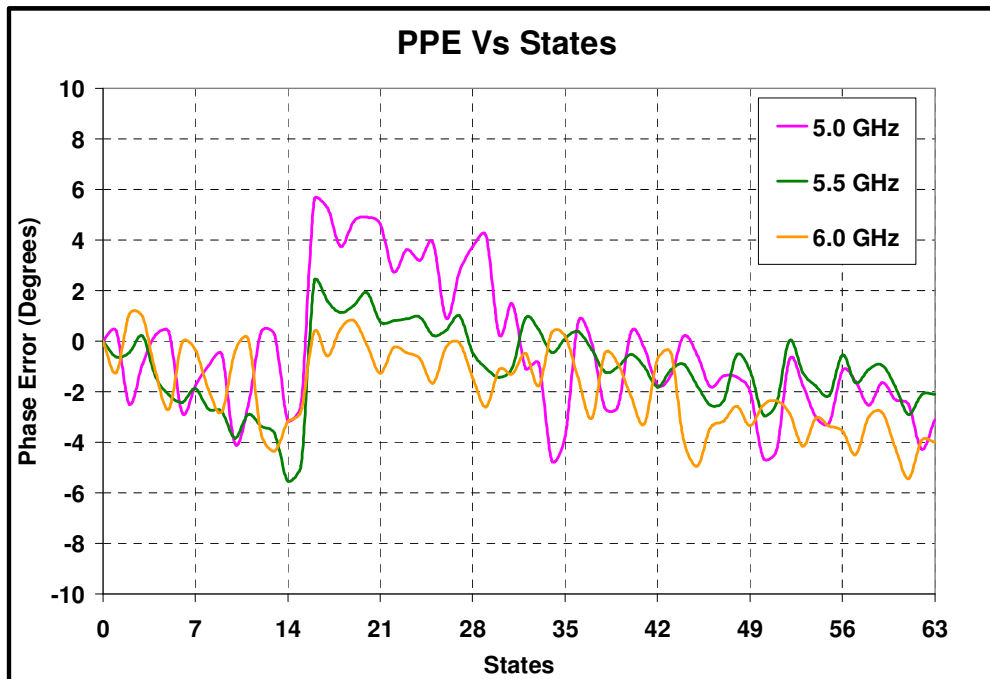
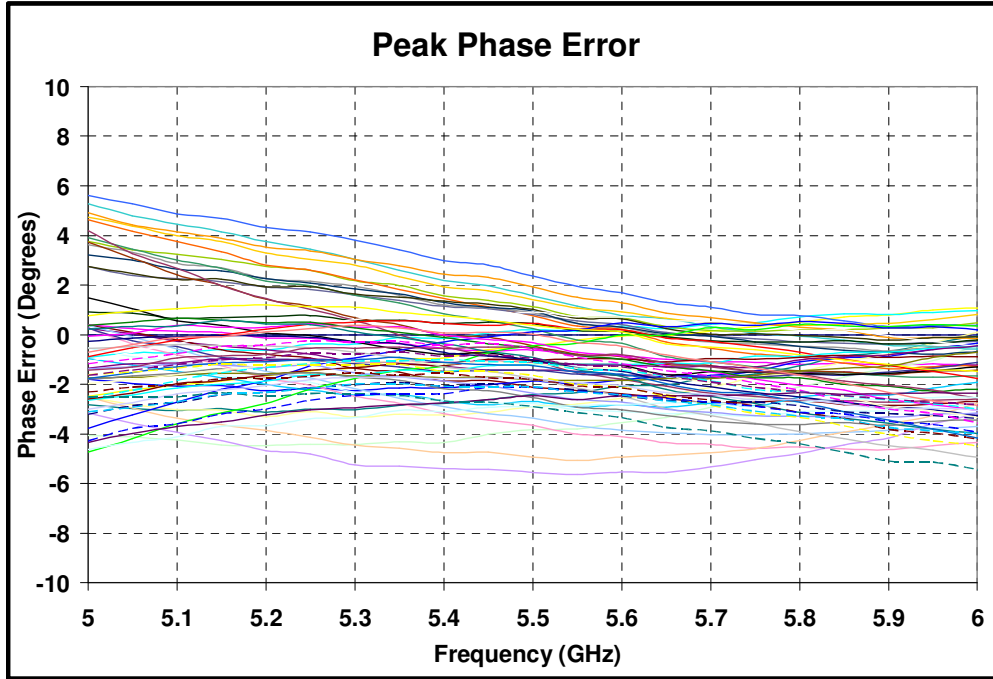

Test Fixture Data

$T_A = 25^\circ C$

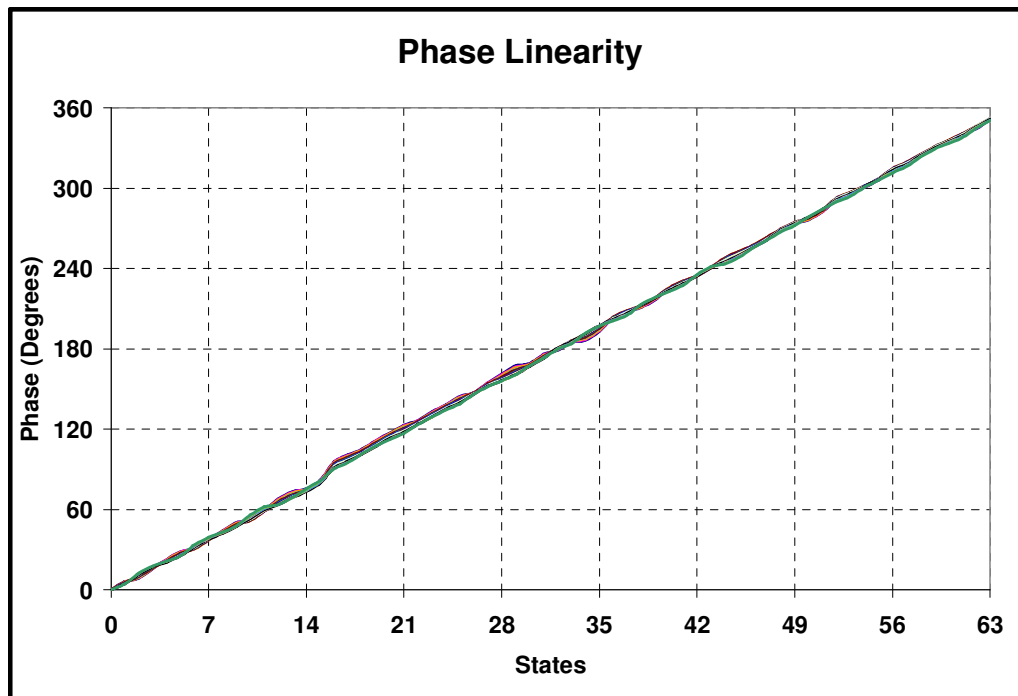
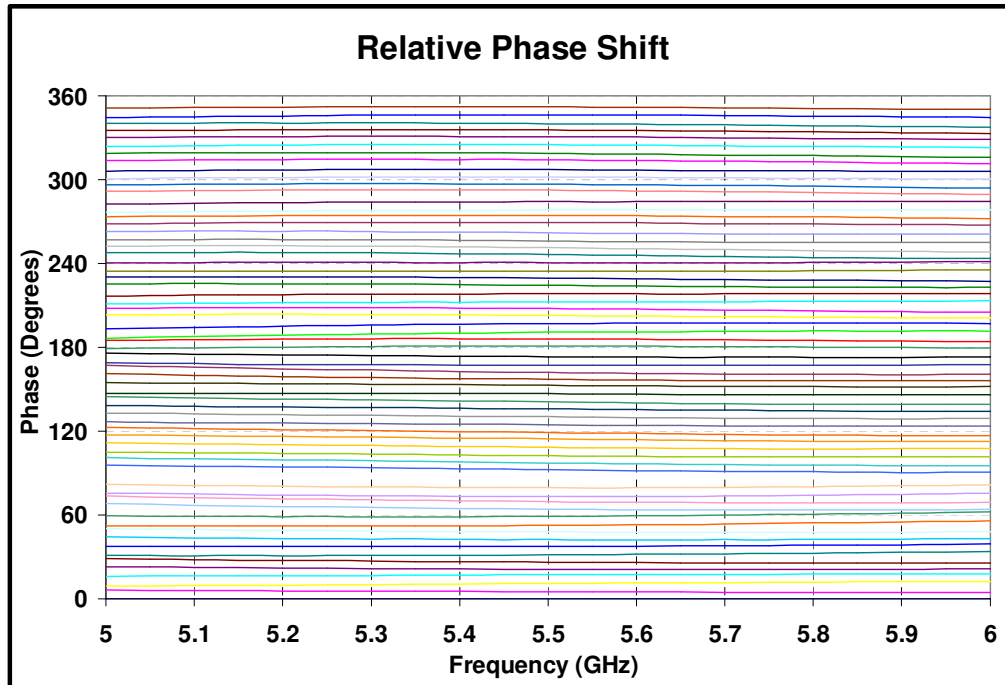

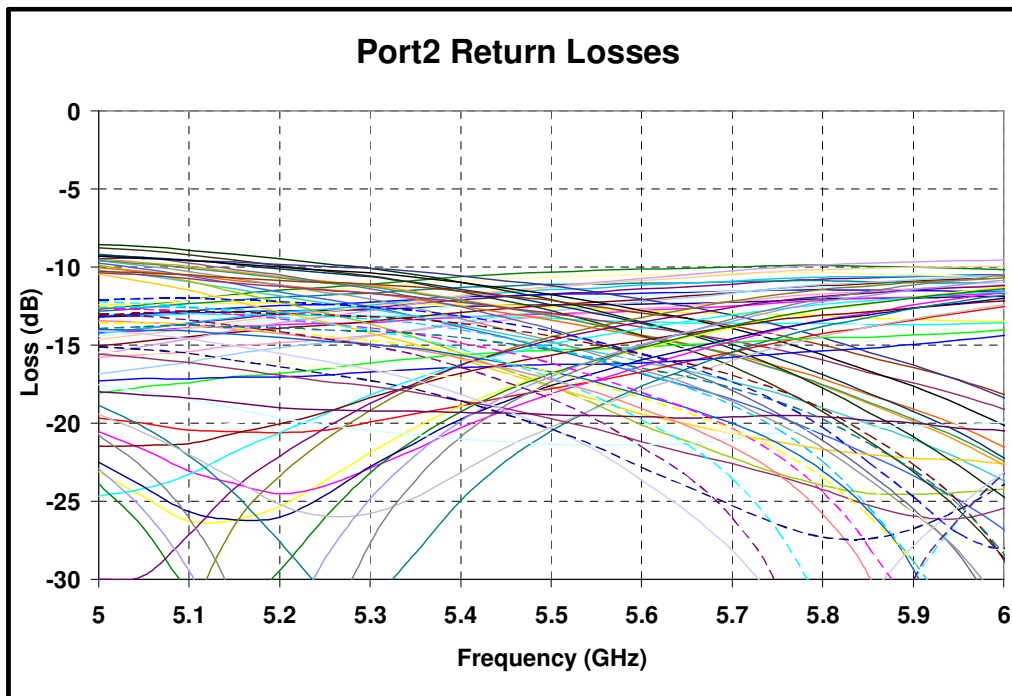
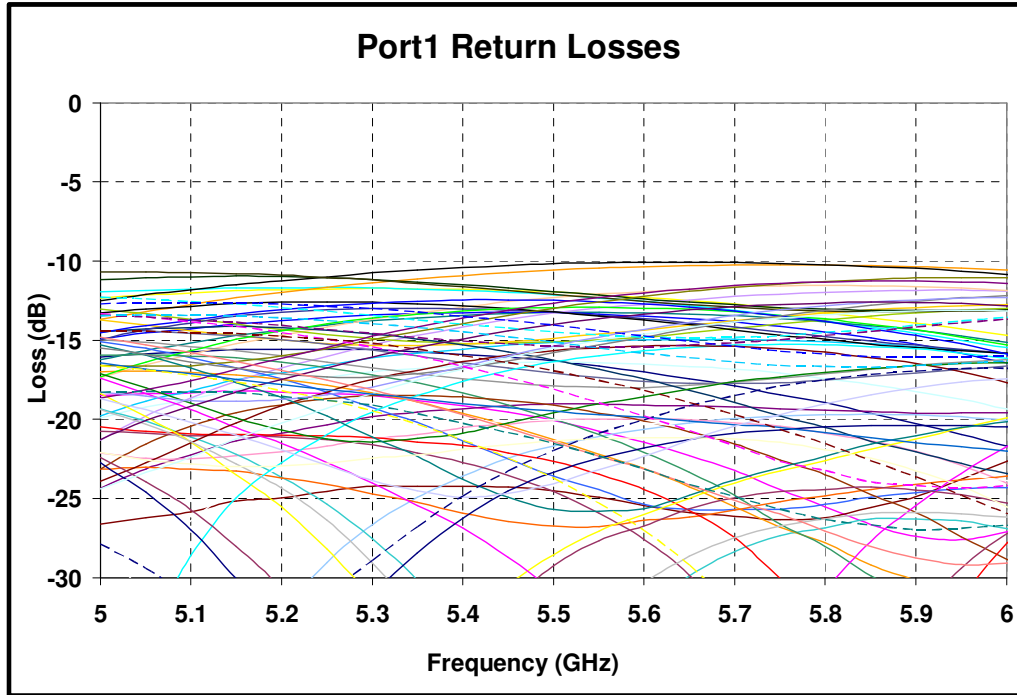
Test Fixture Data $T_A = 25^\circ\text{C}$ 

Test Fixture Data

$T_A = 25^\circ C$

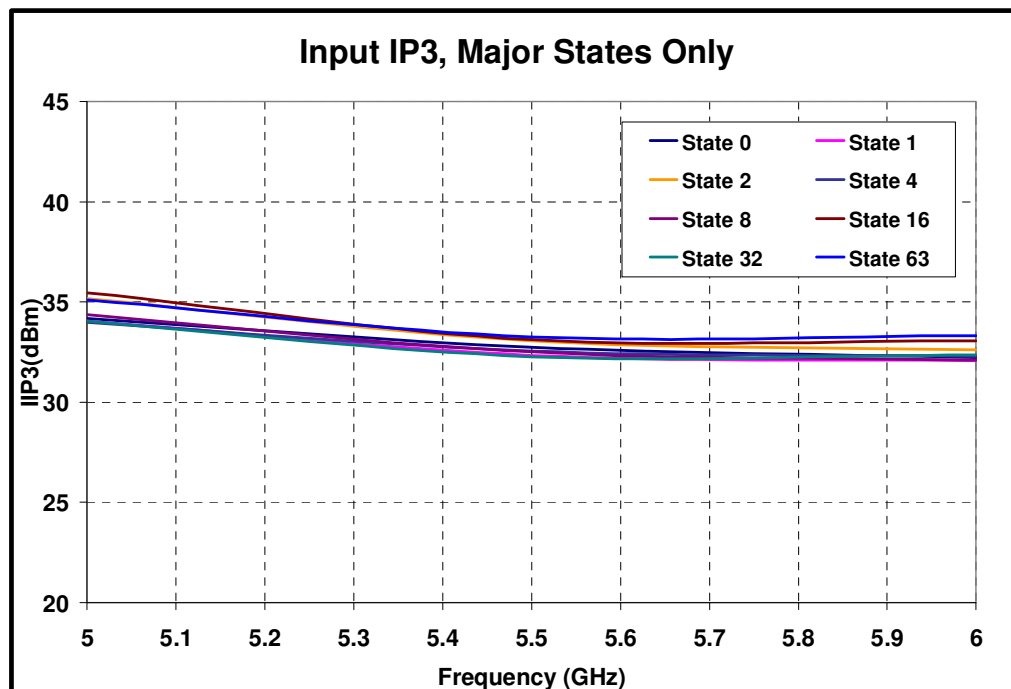
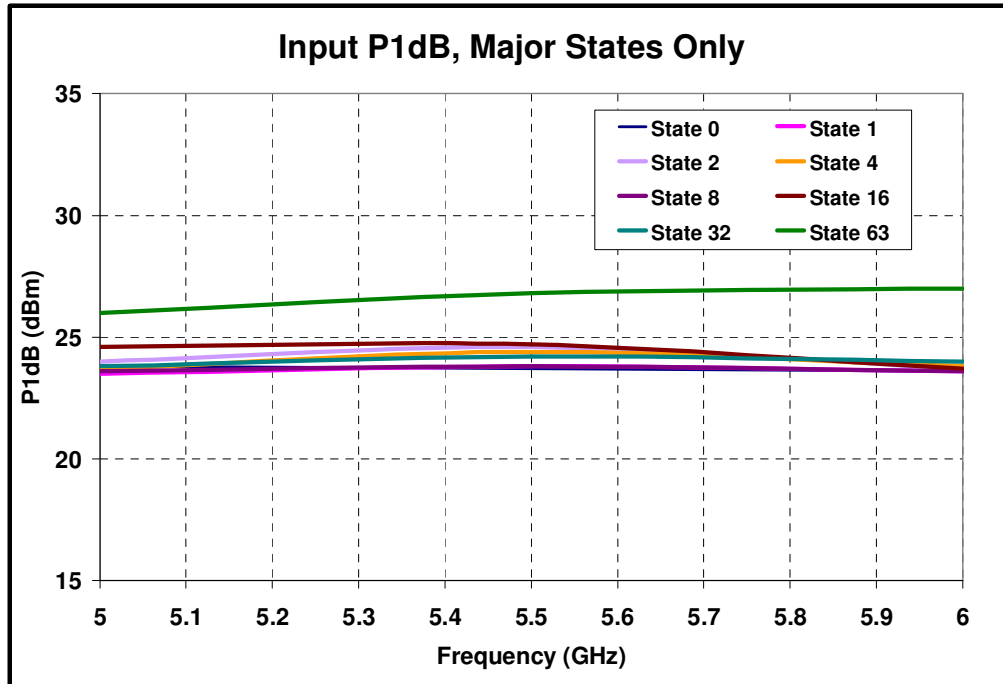

Test Fixture Data

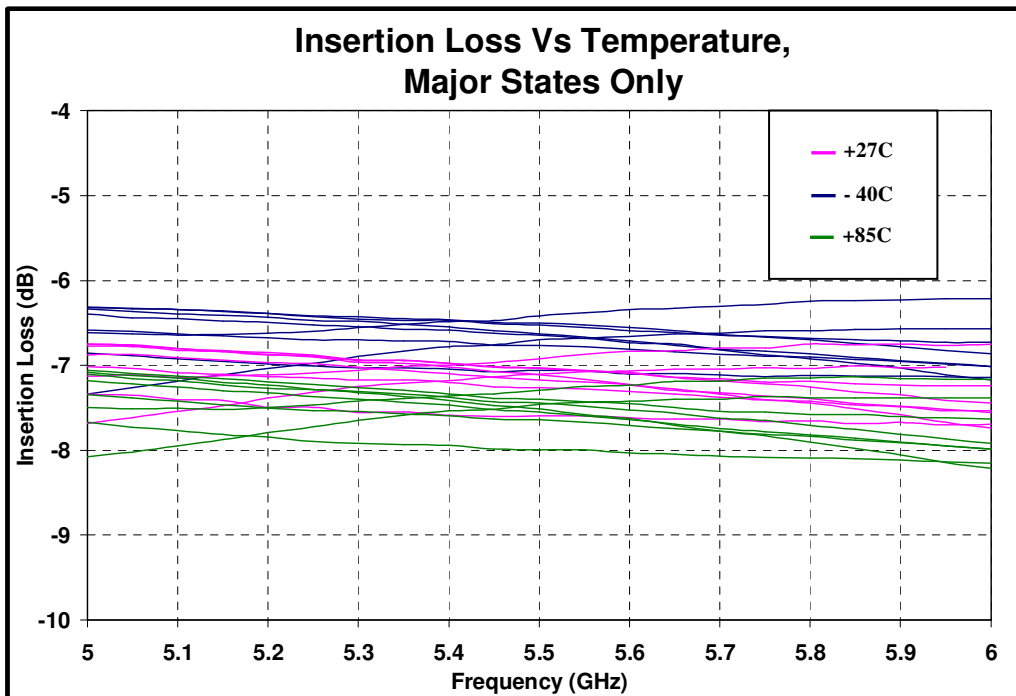
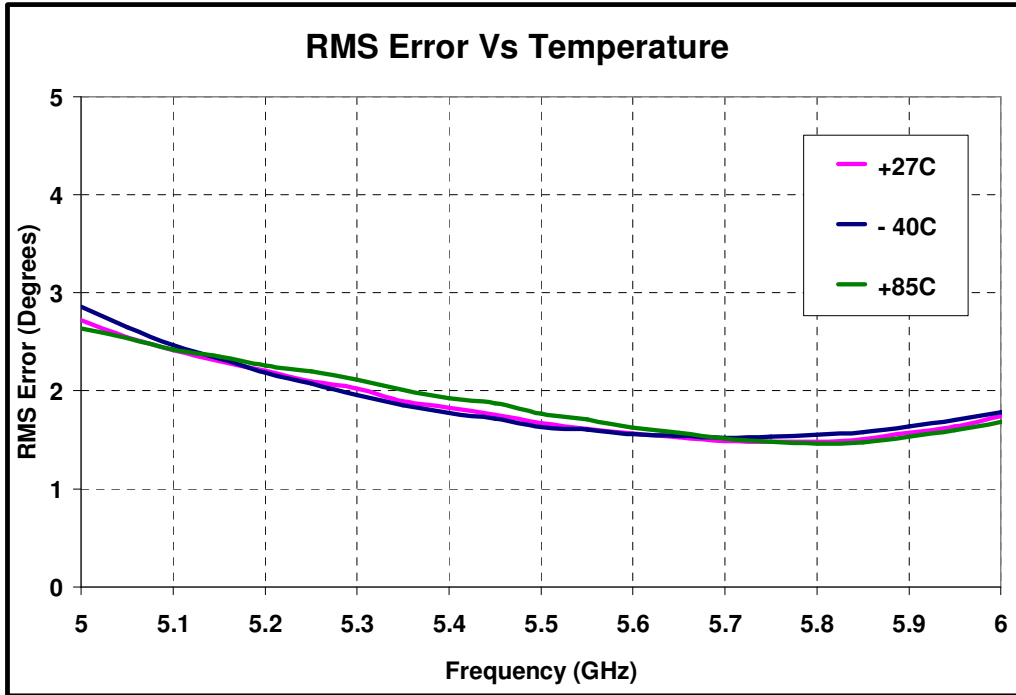

Pin Configuration

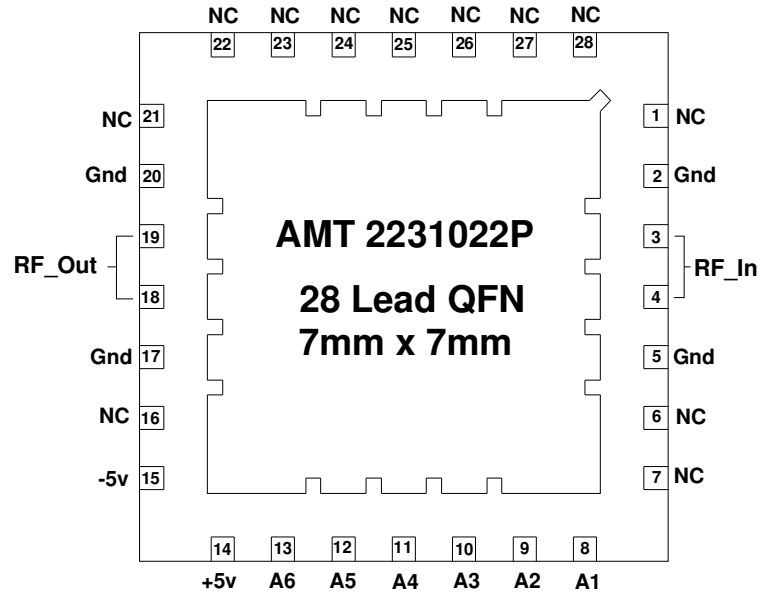

BOTTOM VIEW

Pin Description

QFN PIN Nos.	Description
3, 4	RF_IN
18, 19	RF_OUT
8-13	Controls A1-A6
14	+5V
15	-5V
2, 5, 17, 20	Gnd

Note: All the Other Pins are Not Connected (NC), but need to be externally grounded on the PCB.

Test Board Pattern

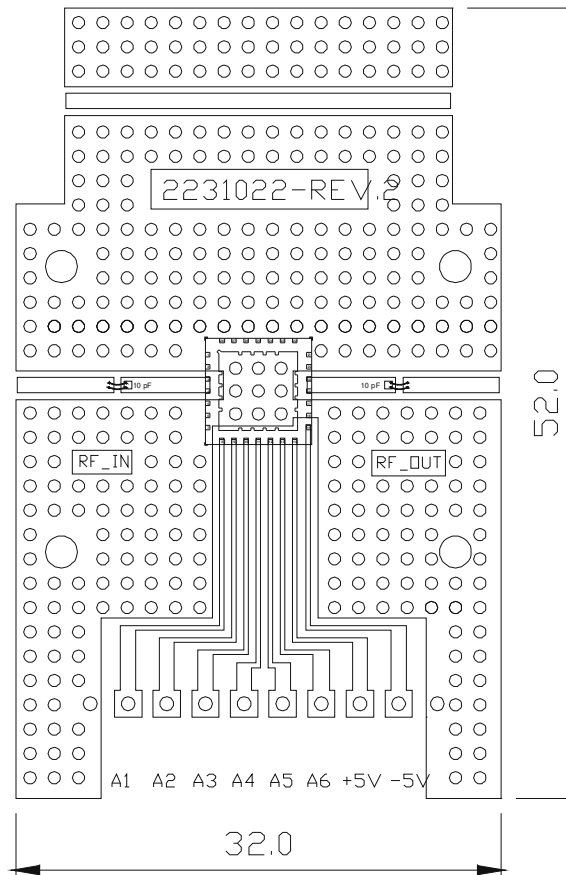

Note:

1. Dimensions in mm.
2. Circuit board material: Rogers 4350, 20mil
3. Input / Output signal lines have 50Ω impedance
4. 10pF capacitors to be used on I/O lines for DC blocking.

Package Outline Drawing

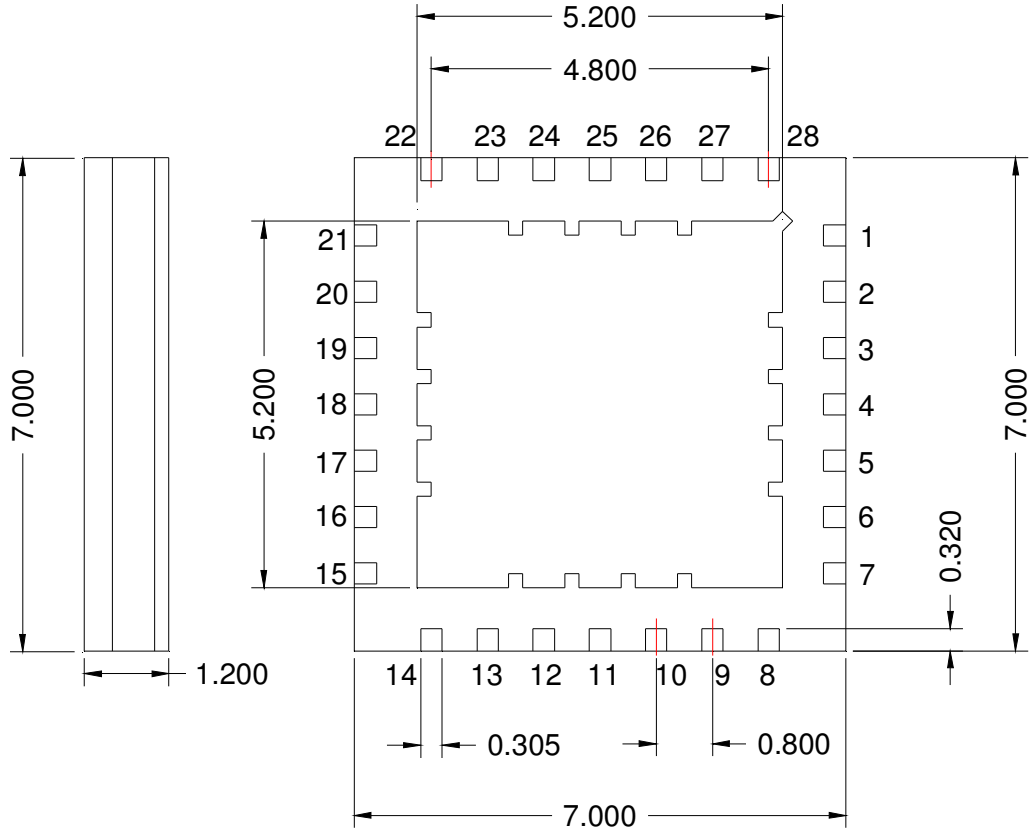

BOTTOM VIEW

Note: All Dimensions are in mm

Truth Table

State	Phase Shift (deg.)	TTL Control (1 = 3.5 to 5 V, 0 = 0 to 0.5 V)					
		A6 (180)	A5 (90)	A4 (45)	A3 (22.5)	A2 (11.25)	A1 (5.625)
0	0	0	0	0	0	0	0
1	5.625	0	0	0	0	0	1
2	11.25	0	0	0	0	1	0
3	16.875	0	0	0	0	1	1
4	22.5	0	0	0	1	0	0
5	28.125	0	0	0	1	0	1
6	33.75	0	0	0	1	1	0
7	39.375	0	0	0	1	1	1
8	45	0	0	1	0	0	0
9	50.625	0	0	1	0	0	1
10	56.25	0	0	1	0	1	0
11	61.875	0	0	1	0	1	1
12	67.5	0	0	1	1	0	0
13	73.125	0	0	1	1	0	1
14	78.75	0	0	1	1	1	0
15	84.375	0	0	1	1	1	1
16	90	0	1	0	0	0	0
17	95.625	0	1	0	0	0	1
18	101.25	0	1	0	0	1	0
19	106.875	0	1	0	0	1	1
20	112.5	0	1	0	1	0	0
21	118.125	0	1	0	1	0	1
22	123.75	0	1	0	1	1	0
23	129.375	0	1	0	1	1	1
24	135	0	1	1	0	0	0
25	140.625	0	1	1	0	0	1
26	146.25	0	1	1	0	1	0
27	151.875	0	1	1	0	1	1
28	157.5	0	1	1	1	0	0
29	163.125	0	1	1	1	0	1
30	168.75	0	1	1	1	1	0
31	174.375	0	1	1	1	1	1
32	180	1	0	0	0	0	0
33	185.625	1	0	0	0	0	1
34	191.25	1	0	0	0	1	0
35	196.875	1	0	0	0	1	1

Truth Table

State	Phase Shift (deg.)	TTL Control (1 = 3.5 to 5 V, 0 = 0 to 0.5 V)					
		A6 (180)	A5 (90)	A4 (45)	A3 (22.5)	A2 (11.25)	A1 (5.625)
36	202.5	1	0	0	1	0	0
37	208.125	1	0	0	1	0	1
38	213.75	1	0	0	1	1	0
39	219.375	1	0	0	1	1	1
40	225	1	0	1	0	0	0
41	230.625	1	0	1	0	0	1
42	236.25	1	0	1	0	1	0
43	241.875	1	0	1	0	1	1
44	247.5	1	0	1	1	0	0
45	253.125	1	0	1	1	0	1
46	258.75	1	0	1	1	1	0
47	264.375	1	0	1	1	1	1
48	270	1	1	0	0	0	0
49	275.625	1	1	0	0	0	1
50	281.25	1	1	0	0	1	0
51	286.875	1	1	0	0	1	1
52	292.5	1	1	0	1	0	0
53	298.125	1	1	0	1	0	1
54	303.75	1	1	0	1	1	0
55	309.375	1	1	0	1	1	1
56	315	1	1	1	0	0	0
57	320.625	1	1	1	0	0	1
58	326.25	1	1	1	0	1	0
59	331.875	1	1	1	0	1	1
60	337.5	1	1	1	1	0	0
61	343.125	1	1	1	1	0	1
62	348.75	1	1	1	1	1	0
63	354.375	1	1	1	1	1	1



GaAs MMIC devices are susceptible to Electrostatic discharge. Proper precautions should be observed during handling, assembly & testing

All information and Specifications are subject to change without prior notice