

DC-10GHz Non-Reflective SPDT Switch

Features

- ◆ DC-10GHz Wide band operation
- ◆ Low Insertion Loss < 2.6 dB @10GHz
- ◆ High Isolation > 42 dB
- ◆ I/O VSWR < 1.9 : 1
- ◆ P_{1dB} (in):21dBm
- ◆ Chip size:2.2 mm X 1.73 mm X 0.1 mm

Typical Applications

- ◆ Military & Space
- ◆ Test Equipments
- ◆ Microwave Radio, RADAR
- ◆ Broadband Telecom

Functional Diagram

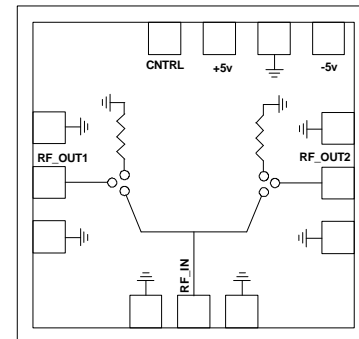

Description

The AMT2542021 is a wideband Reflective single-pole; double throw (SPDT) MMIC chip covering DC to 10GHz. The switch can be operated either in reflective or absorptive mode by grounding the appropriate pad on the die. The Switch features greater than 40 dB Isolation and less than 2.3 dB Insertion Loss in the reflective mode of operation and in the non-reflective configuration, the isolation is >35 dB with the insertion loss less than 2.5 dB up to 10GHz. The Switch offers a high speed switching due to the presence of an on-chip TTL Driver. The input power for 1dB gain compression is 21dBm at midband. The switch operates on +5V/-5V supplies with minimal DC power consumption and is controlled using TTL compatible voltage levels. The die is fabricated using a robust 0.5μm InGaAs pHEMT technology.

Absolute Maximum Ratings ⁽¹⁾

Parameter	Absolute Maximum	Units
RF input Power (common Port)	25	dBm
RF input Power (Toggle ports)	25	dBm
Positive supply Voltage	+6	V
Negative supply voltage	-6	V
Control voltage	-0.5 to +5.5	V
Operating Temperature	-55 to +85	°C
Storage Temperature	-65 to +150	°C

1. Operation beyond these limits may cause permanent damage to the component

Electrical Specifications @ $T_A = 25\text{ }^\circ\text{C}$, $Z_o = 50\ \Omega$

Parameter		Typ.	Units
Frequency	DC-10		GHz
Insertion Loss (max.)	Reflective mode	2.3	dB
	Absorptive mode	2.5	dB
Isolation (min.)	Reflective mode	40	dB
	Absorptive mode	35	dB
Return Loss	Reflective mode	10	dB
	Absorptive mode	10	dB
Input Power for 1dB Compression	DC-10GHz	21	dBm
Driver Bias Voltages		+5, -5	V
Control Voltage		0/+5	V
Switching Speed		10	ns

Note:

1. The above mentioned electrical specifications are measured in 50ohm line test fixture.
2. The RF input & output ports are DC coupled.
3. For reliable operation external DC blocking capacitors are required at the RF input & output ports.

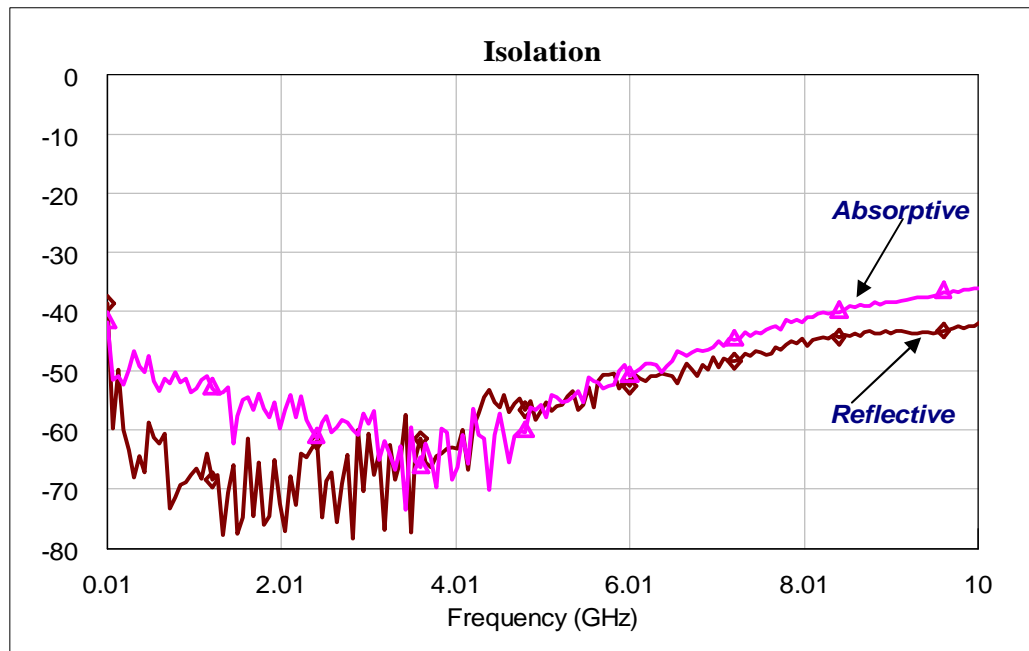
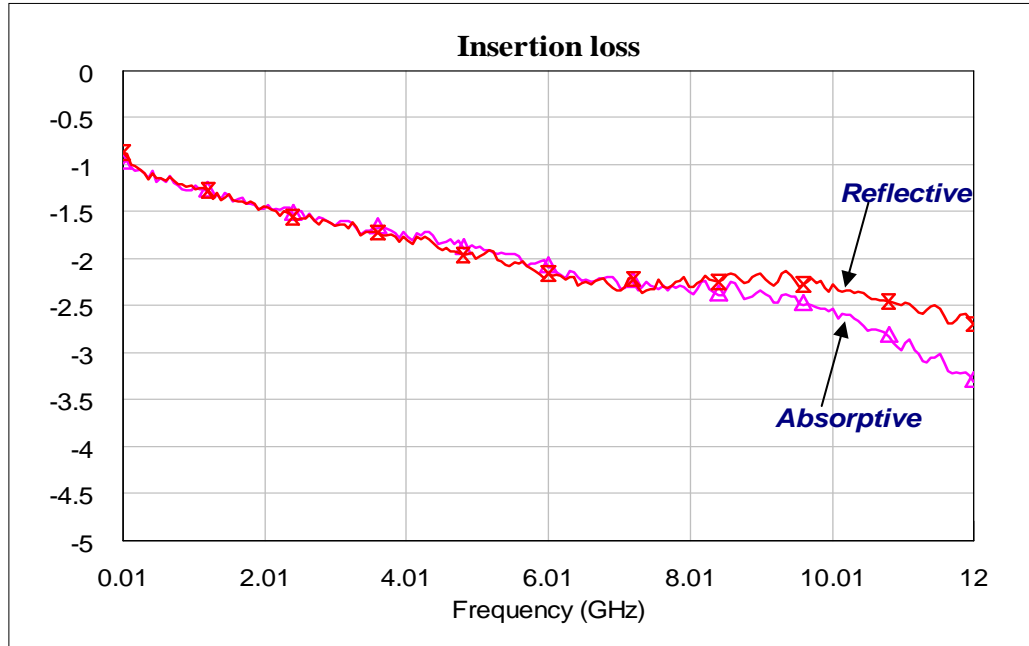
Test fixture dataDriver Bias +5V,-5V; Control 0/+5V; $T_A = 25\text{ }^\circ\text{C}$ 

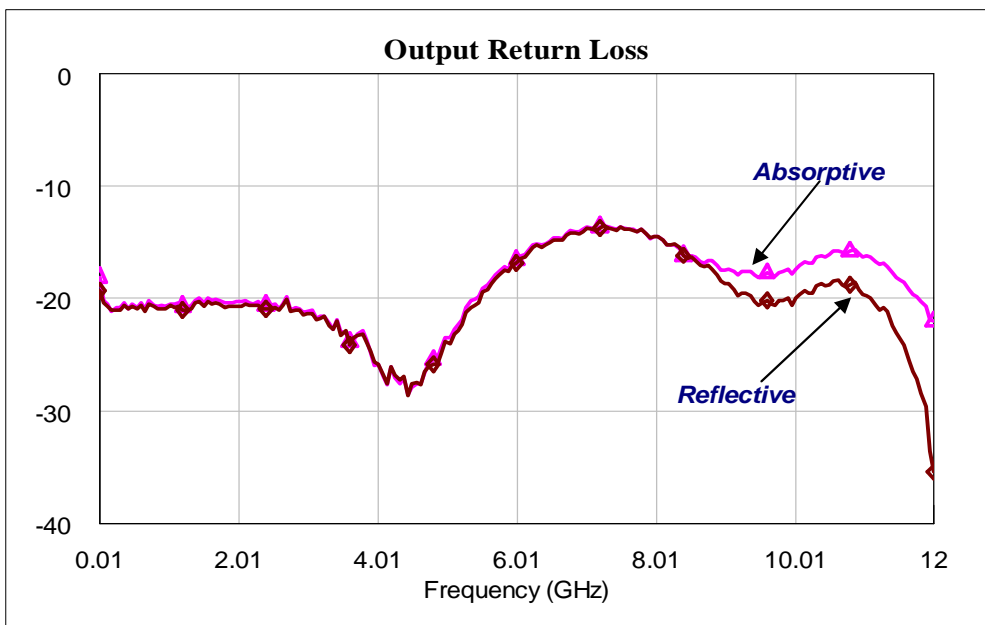
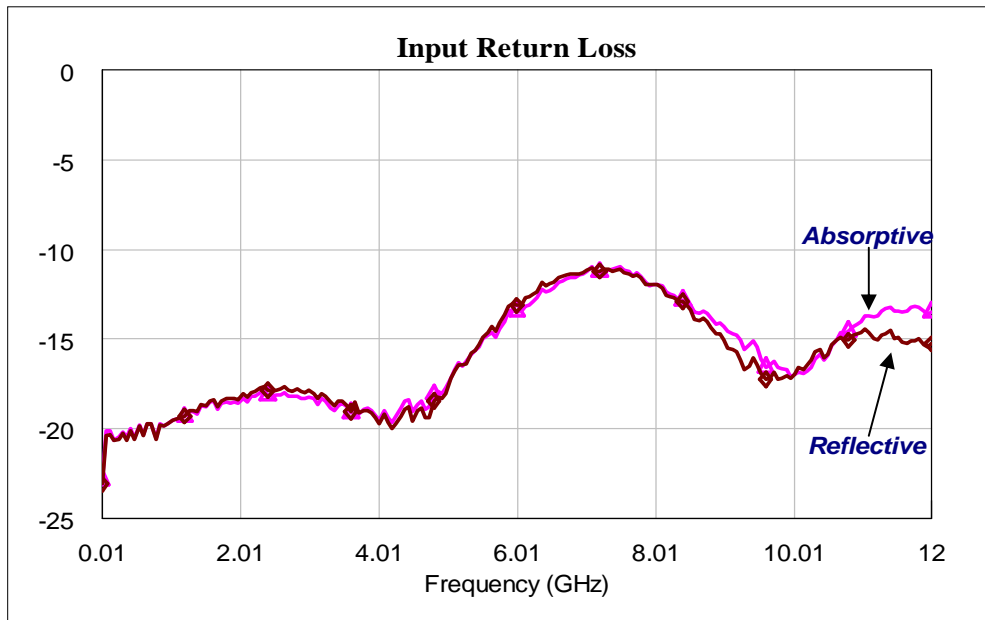
Test fixture dataDriver Bias +5V,-5V; Control 0/+5V; $T_A = 25\text{ }^\circ\text{C}$ 

Truth Table

Control Voltage

State	Bias condition
Low "0"	0 to 0.5 V
High "1"	3.5 V to 5.0 V

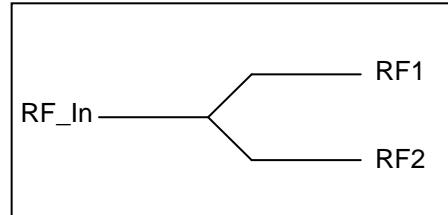

Ctrl_vol	RF_In to RF1	RF_In to RF2
0(Low)	Off	On
1(High)	On	Off

Mechanical Characteristics

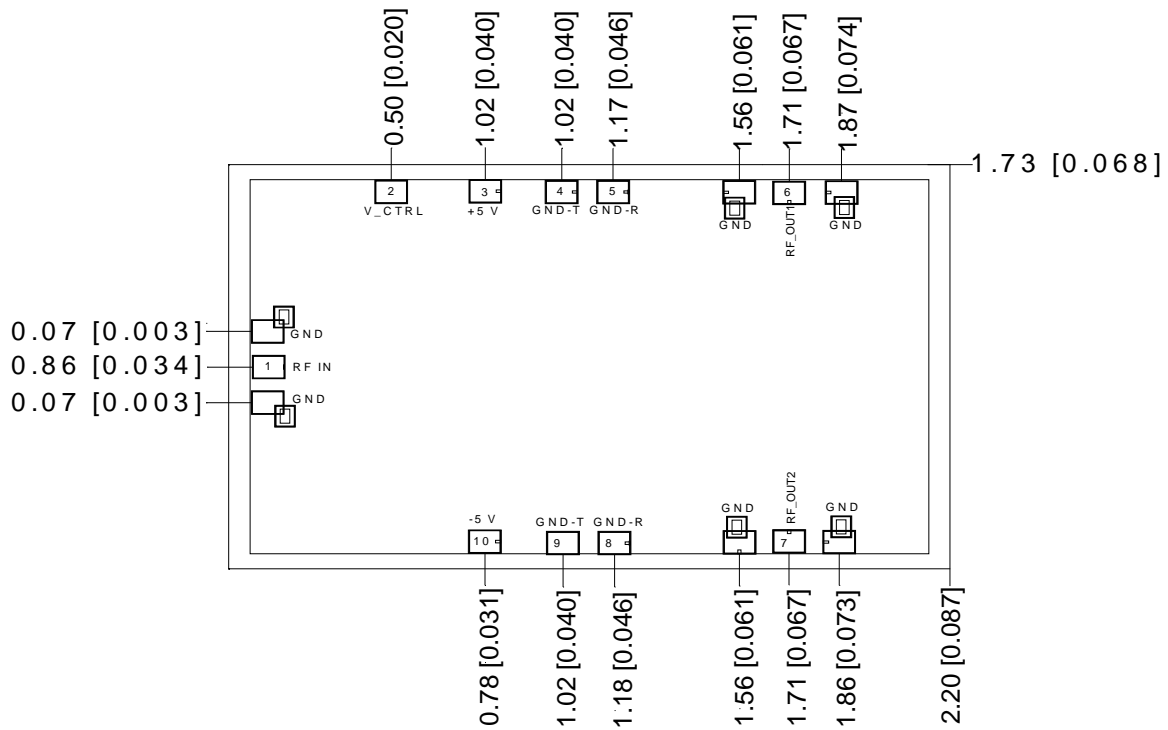

Units: millimeters [inches]

Note:

1. All RF and DC bond pads are 100µm x 100µm
2. Pad no. 1 : RF_In
3. Pad no. 2 : Control Voltage
4. Pad no. 3 : +5 V
5. Pad no. 4,9 : GND Terminative
6. Pad no. 5,8 : GND Reflective
7. Pad no. 6 : RF_Out 1
8. Pad no. 7 : RF_Out 2

Recommended Assembly Diagram

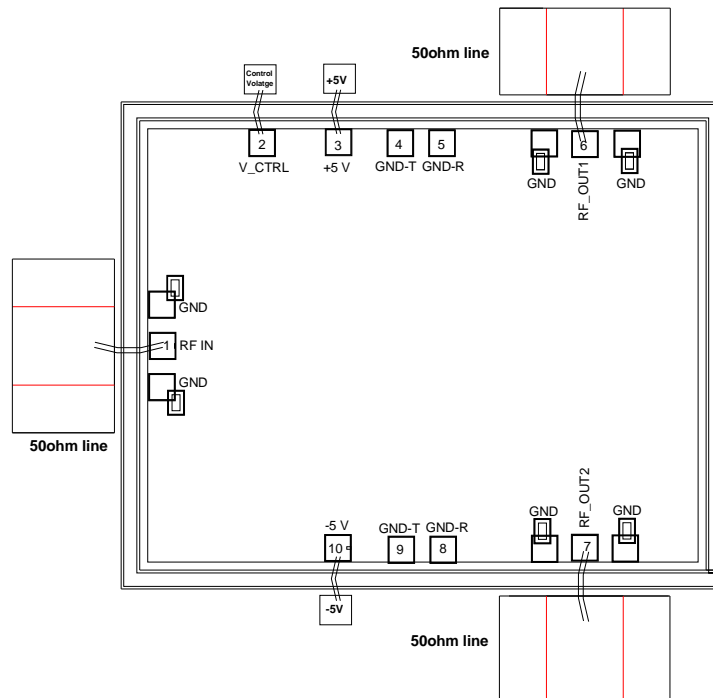

Note:

1. To operate the switch in Absorptive mode, pad nos. 4 & 9 need to be grounded.
2. To operate the switch in Reflective mode, pad nos. 5 & 8 need to be grounded.
3. Two one mil (0.0254mm) bond wires of maximum length of 250microns should be used for RF input and output.
4. The RF input & output are DC Coupled lines.
5. 0.1 μ F capacitors may be additionally used as a bypass for reliable operation at the power supplies.
6. Input and output 50 ohm lines are on either 5mil or 10mil Alumina or RT Duroid substrate.

Die attach: For Epoxy attachment, use of a two-component conductive epoxy is recommended. An epoxy fillet should be visible around the total die periphery. If Eutectic attachment is preferred, use of fluxless AuSn (80/20) 1-2 mil thick preform solder is recommended. Use of AuGe preform should be strictly avoided.

Wire bonding: For DC pad connections use either ball or wedge bonds. For best RF performance, use of 150 - 200 μ m length of wedge bonds is advised. Single Ball bonds of 250-300 μ m though acceptable, may cause a deviation in RF performance.



GaAs MMIC devices are susceptible to Electrostatic discharge. Proper precautions should be observed during handling, assembly & testing

All information and Specifications are subject to change without prior notice